

Cable mounts for flat bars 3-20 mm and section 40x22

Material: Stainless steel

Polyamide with black glass fiber, resistant to UV radiation

FCC

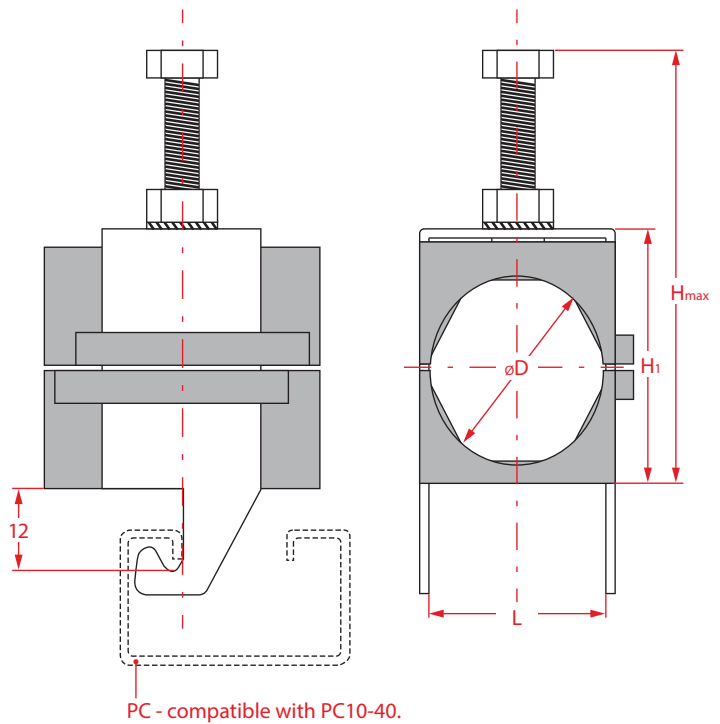

STANDARD

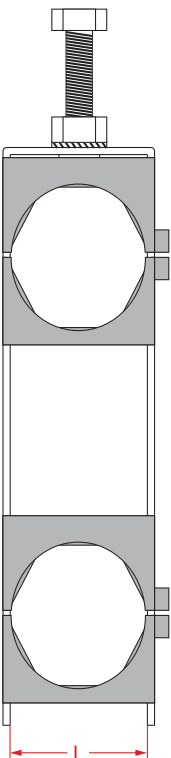

TRIANGLE

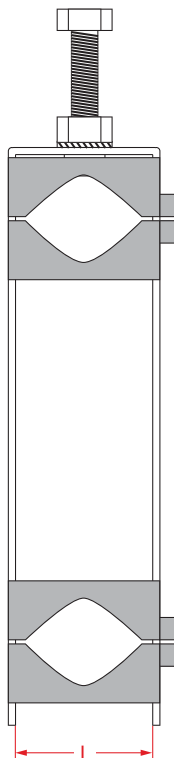

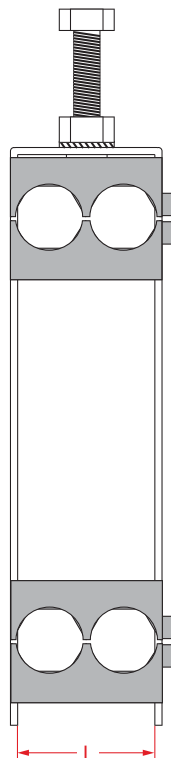

2 ROADS



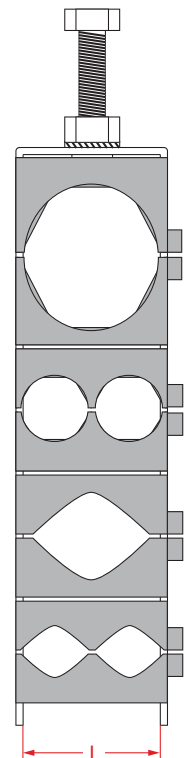

COMBINATION



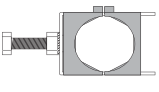
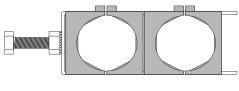
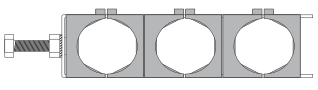
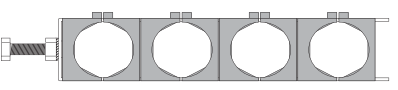

... and more other solutions on request

Figure	Name / code	øD	L	H ₁	H _{max}	 Nm		 gram
	FCC 1 X 4,2	4,2- 5,0	22	18	48	4	50/100/200	41
	FCC 1 X 5	5,2- 6,2	22	18	48	4	50/100/200	41
	FCC 1 X 6	5,5- 6,5	22	18	48	4	50/100/200	41
	FCC 1 X 6,5	6,5- 7,5	22	18	48	4	50/100/200	41
	FCC 1 X 8	7,5- 8,5	22	18	48	4	50/100/200	41
	FCC 1 X 9	8,5- 9,5	22	22	52	4	50/100/200	49
	FCC 1 X 10	9,5- 10,5	22	22	52	4	50/100/200	49
	FCC 1 X 11	10,5- 11,5	22	22	52	4	50/100/200	49
	FCC 1 X 3/8" (14)	13- 14	22	23	52	4	50/100/200	47
	FCC 1 X 1/2" (17)	16- 17	22	30	52	4	50/100	52
	FCC 1 X 18,5	18- 19	32	32	52	6	50	76
	FCC 2 X 19,5	19- 20	32	32	52	6	50	74
	FCC 1 X 24	24,5- 25,5	32	44	52	6	50	96
	FCC 1 X 7/8" (28)	27- 28	32	44	52	6	50	90
	FCC 1 X 1.1/4" (40)	39- 40	46	57	52	8	25/50	144
FCC 1 X 1.5/8" (52)	50- 52	56	68	52	8	25/50	165	
	FCC 2 X 4,2	4,2- 5,0	22	30	60	4	50/100	57
	FCC 2 X 5	5,2- 6,2	22	30	60	4	50/100	57
	FCC 2 X 6	5,5- 6,5	22	30	60	4	50/100	57
	FCC 2 X 6,5	6,5- 7,5	22	30	60	4	50/100	57
	FCC 2 X 8	7,5- 8,5	22	30	60	4	50/100	55
	FCC 2 X 9	8,5- 9,5	22	38	68	4	50/100	70
	FCC 2 X 10	9,5- 10,5	22	38	68	4	50/100	70
	FCC 2 X 11	10,5- 11,5	22	38	68	4	50/100	70
	FCC 2 X 3/8" (14)	13- 14	22	40	70	4	50/100	65
	FCC 2 X 1/2" (17)	16- 17	22	54	84	4	50/100	76
	FCC 2 X 18,5	18- 19	32	57	87	6	50	113
	FCC 2 X 19,5	19- 20	32	57	87	6	50	110
	FCC 2 X 24	24,5- 25,5	32	81	111	6	50	140
	FCC 2 X 7/8" (28)	27- 28	32	81	111	6	50	128
	FCC 2 X 1.1/4" (40)	39- 40	46	106	146	8	25/50	210
FCC 2 X 1.5/8" (52)	50- 52	56	128	168	8	25/50	249	
	FCC 3 X 4,2	4,2- 5,0	22	42	72	4	50/100	73
	FCC 3 X 5	5,2- 6,2	22	42	72	4	50/100	73
	FCC 3 X 6	5,5- 6,5	22	42	72	4	50/100	73
	FCC 3 X 6,5	6,5- 7,5	22	42	72	4	50/100	73
	FCC 3 X 8	7,5- 8,5	22	42	72	4	50/100	71
	FCC 3 X 9	8,5- 9,5	22	54	84	4	50/100	91
	FCC 3 X 10	9,5- 10,5	22	54	84	4	50/100	91
	FCC 3 X 11	10,5- 11,5	22	54	84	4	50/100	91
	FCC 3 X 3/8" (14)	13- 14	22	57	87	4	50/100	84
	FCC 3 X 1/2" (17)	16- 17	22	78	108	4	50	100
	FCC 3 X 18,5	18- 19	32	82	112	6	50	150
	FCC 3 X 19,5	19- 20	32	82	122	6	50	150
	FCC 3 X 24	24,5- 25,5	32	118	148	6	50	184
	FCC 3 X 7/8" (28)	27- 28	32	118	148	6	50	166
	FCC 3 X 1.1/4" (40)	39- 40	46	155	195	8	25	276
FCC 3 X 1.5/8" (52)	50- 52	56	188	228	8	25	333	
	FCC 4 X 4,2	4,2- 5,0	22	54	84	4	50	89
	FCC 4 X 5	5,2- 6,2	22	54	84	4	50	89
	FCC 4 X 6	5,5- 6,5	22	54	84	4	50	89
	FCC 4 X 6,5	6,5- 7,5	22	54	84	4	50	89
	FCC 4 X 8	7,5- 8,5	22	54	84	4	50	86
	FCC 4 X 9	8,5- 9,5	22	70	100	4	50	112
	FCC 4 X 10	9,5- 10,5	22	70	100	4	50	112
	FCC 4 X 11	10,5- 11,5	22	70	100	4	50	122
	FCC 4 X 3/8" (14)	13- 14	22	74	104	4	50	102
	FCC 4 X 1/2" (17)	16- 17	22	102	132	4	50	124
	FCC 4 X 18,5	18- 19	32	107	137	6	25	192
	FCC 4 X 19,5	19- 20	32	107	137	6	25	191
	FCC 4 X 24	24,5- 25,5	32	155	185	6	25	253
	FCC 4 X 7/8" (28)	27- 28	32	155	185	6	25	229
	FCC 4 X 1.1/4" (40)	39- 40	46	204	244	8	25	342
FCC 4 X 1.5/8" (52)	50- 52	56	248	288	8	25	417	

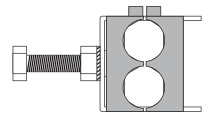
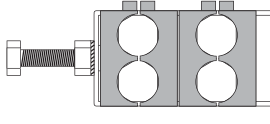
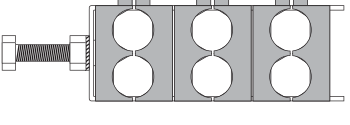





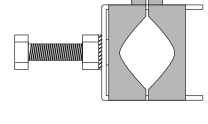
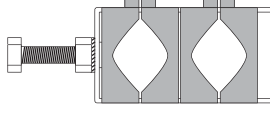
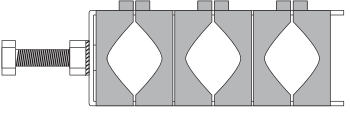
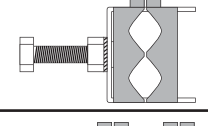
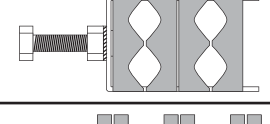
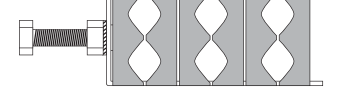





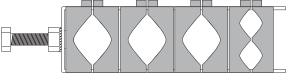

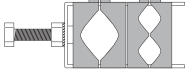
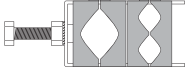

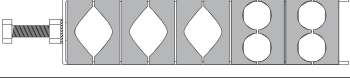

2 ROADS

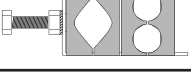
Figure	Name / code	øD	L	H ₁	H _{max}	 Nm		 gram
	FCC 2 X 5/22	5,0- 6,0	22	17	47	4	50/100/200	47
	FCC 2 X 6/22	5,6- 6,5	22	20	50	4	50/100/200	47
	FCC 2 X 6,5/22	6,5- 7,3	22	20	50	4	50/100/200	47
	FCC 2 X 8/22	8,0- 9,0	22	20	50	4	50/100/200	47
	FCC 2 X 10	10,0- 11,0	32	23	52	6	50/100	68
	FCC 2 X 11	10,0- 11,0	32	23	52	6	50/100	68
	FCC 4 X 5/22	5,0- 6,0	22	28	58	4	50/100	66
	FCC 4 X 6/22	5,6- 6,5	22	34	64	4	50/100	66
	FCC 4 X 6,5/22	6,5- 7,3	22	34	64	4	50/100	66
	FCC 4 X 8/22	8,0- 9,0	22	34	64	4	50/100	66
	FCC 4 X 10	10,0- 11,0	32	40	70	6	50	93
	FCC 4 X 11	10,0- 11,0	32	40	70	6	50	93
	FCC 6 X 5/22	5,0- 6,0	22	39	69	4	50/100	84
	FCC 6 X 6/22	5,6- 6,5	22	48	78	4	50/100	84
	FCC 6 X 6,5/22	6,5- 7,3	22	48	78	4	50/100	84
	FCC 6 X 8/22	8,0- 9,0	22	48	78	4	50/100	84
	FCC 6 X 10	10,0- 11,0	32	57	107	6	50	110
	FCC 6 X 11	10,0- 11,0	32	57	107	6	50	110

TRIANGLE

Figure	Name / code	øD	L	H ₁	H _{max}	 Nm		 gram
	FCC 1 X 4-8	4,0- 8,0	22	26	71	4	50/100	50
	FCC 1 X 9-16	9,0- 16,0	22	34	79	4	50/100	52
	FCC 1 X 12-22	12,0- 22,0	22	41	86	4	50/100	56
	FCC 1 X 14-22	14,0- 22,0	32	51	96	6	50	89
	FCC 1 X 18-24	18,0- 24,0	32	53	98	6	50	102
	FCC 1 X 26-32	26,0- 32,0	32	62	107	6	50	108
	FCC 2 X 4-8	4,0- 8,0	22	43	103	4	50/100	68
	FCC 2 X 9-16	9,0- 16,0	22	60	120	4	50/100	75
	FCC 2 X 12-22	12,0- 22,0	22	74	134	4	50	86
	FCC 2 X 14-22	14,0- 22,0	32	93	153	6	50	149
	FCC 2 X 18-24	18,0- 24,0	32	97	157	6	50	174
	FCC 2 X 26-32	26,0- 32,0	32	115	175	6	50	183
	FCC 2 X 124-22 + 26-32	14,00- 22,00 26,00- 32,00	32	105	160	6	50	176
	FCC 3 X 4-8	4,0- 8,0	22	59	119	4	50/100	86
	FCC 3 X 9-16	9,0- 16,0	22	84	144	4	50/100	96
	FCC 3 X 12-22	12,0- 22,0	22	105	165	4	50	113
	FCC 3 X 14-22	14,0- 22,0	32	135	195	6	50	235
	FCC 3 X 18-24	18,0- 24,0	32	141	221	6	50	241
FCC 3 X 26-32	26,0- 32,0	32	163	228	6	50	256	
	FCC 2 X 8-14	8,0- 14,0	32	36	96	6	50	71
	FCC 4 X 8-14	8,0- 14,0	32	63	108	6	50	113
	FCC 6 X 8-14	8,0- 14,0	32	90	150	6	50	149

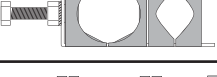
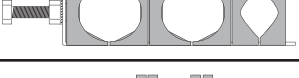
OTHER COMBINATIONS

Figure	Name / code	∅D	L	H ₁	H _{max}	 Nm		 gram
	FCC 3 X 18-24 + 2 X 8-12	3 X 18-24 2 X 8-12	32	168	228	6	50	276
	FCC 2 X 18-24 + 2 X 8-12	2 X 18-24 2 X 8-12	32	124	184	6	50	209
	FCC 18-24 + 2 X 8-12	1 X 18-24 2 X 8-12	32	80	140	6	50	142
	FCC 14-32 + 2 X 8-14	14-32 2 X 8-14	32	90	135	6	50	146
	FCC 3 X 12-22 + 2 X 6,5/22	3 X 12-22 2 X 6,5/22	22	120	180	6	50	127
	FCC 3 X 12-22 + 4 X 6,5/22	3 X 12-22 4 X 6,5/22	22	134	194	4	50	177
	FCC 3 X 12-22 + 6 X 6,5/22	3 X 12-22 6 X 6,5/22	22	147	207	4	50	199
	FCC 3 X 12-22 + 6 X 5/22	3 X 12-22 6 X 5/22	22	140	207	4	50	184
	FCC 12-22 + 6 X 5/22	12-22 6 X 5/22	22	74	119	4	50	100
	FCC 3 X 12-22 + 6,5	3 X 12-22 6,5	22	119	179	4	50	126
	FCC 12-22 + 2 X 5/22	12-22 2 X 5/22	22	52	97	4	50	72
	FCC 12-22 + 4 X 5/22	12-22 4 X 5/22	22	63	108	4	50	85
	FCC 12-22 + 2 X 6,5/22	12-22 2 X 6,5/22	22	55	100	4	50	74
	FCC 12-22 + 4 X 6,5/22	12-22 4 X 6,5/22	22	68	113	4	50	91
	FCC 12-22 + 6,5	12-22 6,5	22	53	98	4	50	71
	FCC 9-16 + 6,5	9-16 6,5	22	46	91	4	50	66
	FCC 4,2 + 9-16	4,2 9-16	22	46	91	4	50	67
	FCC 3 X 4,2 + 4,2 + 9-16	4,2 4,2 9-16	22	58	103	4	50	83
	FCC 14-32 + 2 X 10	14-32 2 X 10	32	80	125	6	50	138