

Cable clamps mounts for angles 40 mm

Material: Stainless steel

Polyamide with black glass fiber, resistant to UV radiation

FCA4

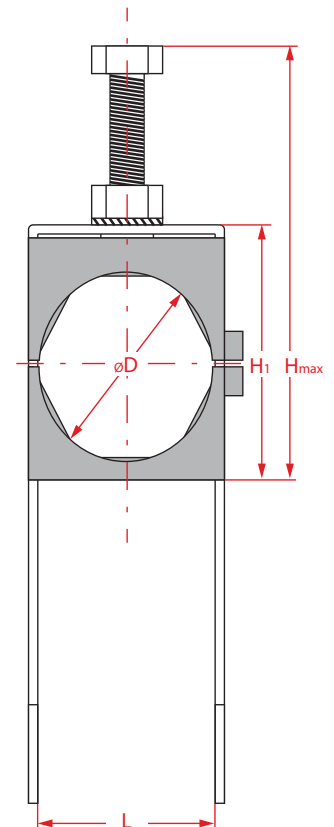
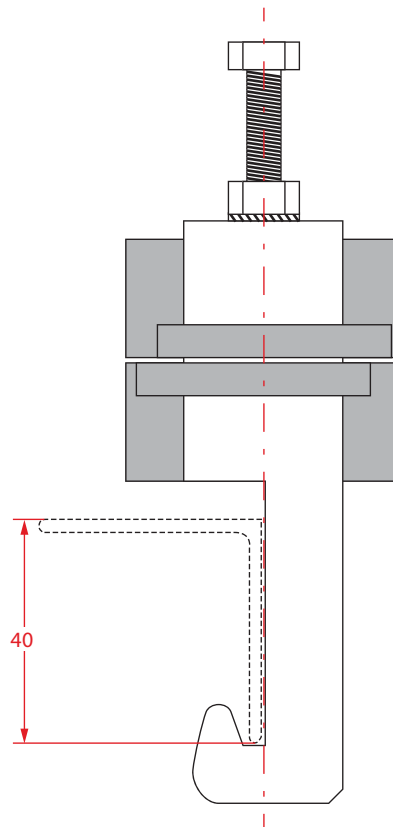

STANDARD

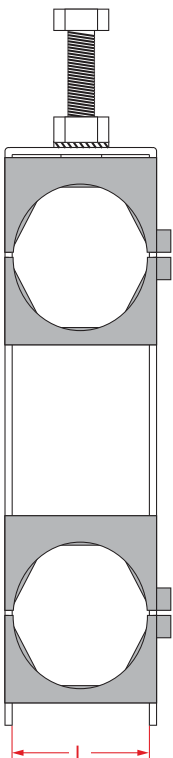

TRIANGLE

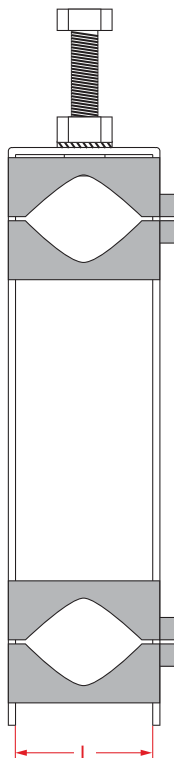



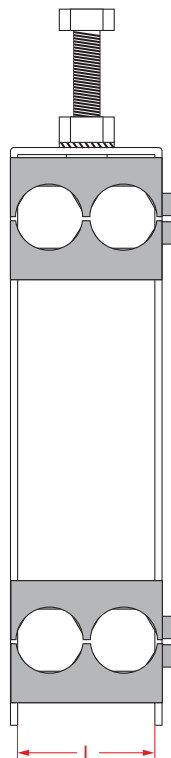

2 ROADS

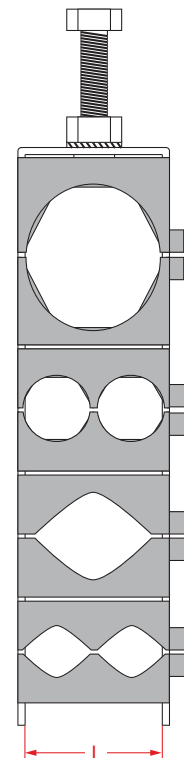



COMBINATION

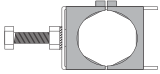
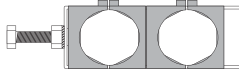
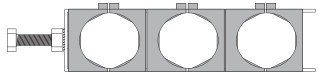



... and more other solutions on request

Figure	Name / code	øD	L	H1	Hmax	 Nm		 gram
	FCA4 1 X 4,2	4,2- 5,0	22	18	63	4	50/100/200	51
	FCA4 1 X 5	5,2- 6,2	22	18	63	4	50/100/200	51
	FCA4 1 X 6	5,5- 6,5	22	18	63	4	50/100/200	51
	FCA4 1 X 6,5	6,5- 7,5	22	18	63	4	50/100/200	51
	FCA4 1 X 8	7,5- 8,5	22	18	63	4	50/100/200	51
	FCA4 1 X 9	8,5- 9,5	22	22	67	4	50/100	50
	FCA4 1 X 10	9,5- 10,5	22	22	67	4	50/100	59
	FCA4 1 X 11	10,5- 11,5	22	22	67	4	50/100	59
	FCA4 1 X 3/8" (14)	13- 14	22	23	68	4	50/100	59
	FCA4 1 X 1/2" (17)	16- 17	22	30	75	4	50/100	57
	FCA4 1 X 18,5	18- 19	32	32	77	6	50	90
	FCA4 2 X 19,5	19- 20	32	32	77	6	50	88
	FCA4 1 X 24	24,5- 25,5	32	44	90	6	50	110
	FCA4 1 X 7/8" (28)	27- 28	32	44	90	6	50	104
	FCA4 1 X 1.1/4" (40)	39- 40	46	57	117	8	25	162
	FCA4 1 X 1.5/8" (52)	50- 52	56	68	128	8	25	183
	FCA4 2 X 4,2	4,2- 5,0	22	30	75	4	50/100	67
	FCA4 2 X 5	5,2- 6,2	22	30	75	4	50/100	67
	FCA4 2 X 6	5,5- 6,5	22	30	75	4	50/100	67
	FCA4 2 X 6,5	6,5- 7,5	22	30	75	4	50/100	67
	FCA4 2 X 8	7,5- 8,5	22	30	75	4	50/100	65
	FCA4 2 X 9	8,5- 9,5	22	38	83	4	50/100	82
	FCA4 2 X 10	9,5- 10,5	22	38	83	4	50/100	82
	FCA4 2 X 11	10,5- 11,5	22	38	83	4	50/100	82
	FCA4 2 X 3/8" (14)	13- 14	22	40	85	4	50/100	75
	FCA4 2 X 1/2" (17)	16- 17	22	54	99	4	50/100	75
	FCA4 2 X 18,5	18- 19	32	57	102	6	50	127
	FCA4 2 X 19,5	19- 20	32	57	102	6	50	124
	FCA4 2 X 24	24,5- 25,5	32	81	126	6	50	154
	FCA4 2 X 7/8" (28)	27- 28	32	81	126	6	50	142
	FCA4 2 X 1.1/4" (40)	39- 40	46	106	166	8	25	228
	FCA4 2 X 1.5/8" (52)	50- 52	56	128	188	8	25	267
	FCA4 3 X 4,2	4,2- 5,0	22	42	87	4	50	83
	FCA4 3 X 5	5,2- 6,2	22	42	87	4	50	83
	FCA4 3 X 6	5,5- 6,5	22	42	87	4	50	83
	FCA4 3 X 6,5	6,5- 7,5	22	42	87	4	50	83
	FCA4 3 X 8	7,5- 8,5	22	42	87	4	50	83
	FCA4 3 X 9	8,5- 9,5	22	54	99	4	50	101
	FCA4 3 X 10	9,5- 10,5	22	54	99	4	50	101
	FCA4 3 X 11	10,5- 11,5	22	54	99	4	50	101
	FCA4 3 X 3/8" (14)	13- 14	22	57	102	4	50	94
	FCA4 3 X 1/2" (17)	16- 17	22	78	123	4	50	110
	FCA4 3 X 18,5	18- 19	32	82	127	6	50	164
	FCA4 3 X 19,5	19- 20	32	82	127	6	50	160
	FCA4 3 X 24	24,5- 25,5	32	118	163	6	25	198
	FCA4 3 X 7/8" (28)	27- 28	32	118	163	6	25	180
	FCA4 3 X 1.1/4" (40)	39- 40	46	155	215	8	25	292
	FCA4 3 X 1.5/8" (52)	50- 52	56	188	248	8	25	351
	FCA4 4 X 4,2	4,2- 5,0	22	54	99	4	50	99
	FCA4 4 X 5	5,2- 6,2	22	54	99	4	50	99
	FCA4 4 X 6	5,5- 6,5	22	54	99	4	50	99
	FCA4 4 X 6,5	6,5- 7,5	22	54	99	4	50	99
	FCA4 4 X 8	7,5- 8,5	22	54	99	4	50	99
	FCA4 4 X 9	8,5- 9,5	22	70	115	4	50	122
	FCA4 4 X 10	9,5- 10,5	22	70	115	4	50	122
	FCA4 4 X 11	10,5- 11,5	22	70	115	4	50	122
	FCA4 4 X 3/8" (14)	13- 14	22	74	119	4	50	112
	FCA4 4 X 1/2" (17)	16- 17	22	102	147	4	50	134
	FCA4 4 X 18,5	18- 19	32	107	152	6	25	206
	FCA4 4 X 19,5	19- 20	32	107	152	6	25	205
	FCA4 4 X 24	24,5- 25,5	32	155	200	6	25	267
	FCA4 4 X 7/8" (28)	27- 28	32	155	200	6	25	244
	FCA4 4 X 1.1/4" (40)	39- 40	46	204	269	8	25	360
	FCA4 4 X 1.5/8" (52)	50- 52	56	248	313	8	25	435

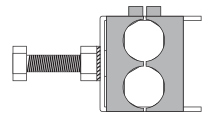
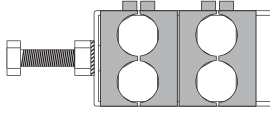
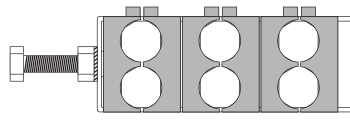

2 ROADS

Figure	Name / code	øD	L	H ₁	H _{max}	 Nm		 gram
	FCA4 2 X 5/22	5,0- 6,0	22	17	62	4	50/100/200	58
	FCA4 2 X 6/22	5,6- 6,5	22	20	75	4	50/100/200	58
	FCA4 2 X 6,5/22	6,5- 7,3	22	20	75	4	50/100/200	58
	FCA4 2 X 8/22	8,0- 9,0	22	20	75	4	50/100/200	58
	FCA4 2 X 10	10,0- 11,0	32	23	78	6	50/100	78
	FCA4 2 X 11	10,0- 11,0	32	23	78	6	50/100	78
	FCA4 4 X 5/22	5,0- 6,0	22	28	73	4	50/100	76
	FCA4 4 X 6/22	5,6- 6,5	22	34	79	4	50/100	76
	FCA4 4 X 6,5/22	6,5- 7,3	22	34	79	4	50/100	76
	FCA4 4 X 8/22	8,0- 9,0	22	34	79	4	50/100	76
	FCA4 4 X 10	10,0- 11,0	32	40	85	6	50	83
	FCA4 4 X 11	10,0- 11,0	32	40	85	6	50	94
	FCA4 6 X 5/22	5,0- 6,0	22	39	84	4	50	94
	FCA4 6 X 6/22	5,6- 6,5	22	48	93	4	50	94
	FCA4 6 X 6,5/22	6,5- 7,3	22	48	93	4	50	94
	FCA4 6 X 8/22	8,0- 9,0	22	48	93	4	50	94
	FCA4 6 X 10	10,0- 11,0	32	57	122	6	50	110
	FCA4 6 X 11	10,0- 11,0	32	57	122	6	50	1110

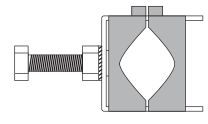
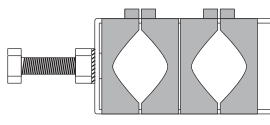
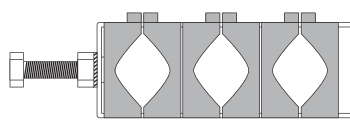
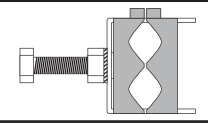
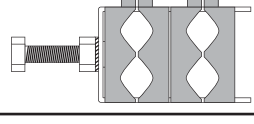
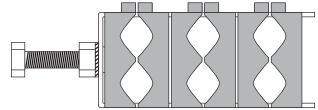
TRIANGLE

Figure	Name / code	øD	L	H ₁	H _{max}	 Nm		 gram
	FCA4 1 X 4-8	4,0- 8,0	22	26	71	4	50/100	62
	FCA4 1 X 9-16	9,0- 16,0	22	34	79	4	50/100	64
	FCA4 1 X 12-22	12,0- 22,0	22	41	86	4	50/100	68
	FCA4 1 X 14-22	14,0- 22,0	32	51	96	6	50	101
	FCA4 1 X 18-24	18,0- 24,0	32	53	98	6	50	118
	FCA4 1 X 26-32	26,0- 32,0	32	62	107	6	50	124
	FCA4 2 X 4-8	4,0- 8,0	22	43	118	4	50/100	78
	FCA4 2 X 9-16	9,0- 16,0	22	60	135	4	50/100	85
	FCA4 2 X 12-22	12,0- 22,0	22	74	149	4	50	96
	FCA4 2 X 14-22	14,0- 22,0	32	93	168	6	50	159
	FCA4 2 X 18-24	18,0- 24,0	32	97	172	6	50	188
	FCA4 2 X 26-32	26,0- 32,0	32	115	190	6	50	197
	FCA4 2 X 14-22 + 26-32	14,00-22,00 26,00- 32,00	32	105	165	6	50	205
	FCA4 3 X 4-8	4,0- 8,0	22	59	119	4	50	96
	FCA4 3 X 9-16	9,0- 16,0	22	84	144	4	50	96
	FCA4 3 X 12-22	12,0- 22,0	22	105	165	4	50	123
	FCA4 3 X 14-22	14,0- 22,0	32	135	195	6	50	149
	FCA4 3 X 18-24	18,0- 24,0	32	141	201	6	50	255
	FCA4 3 X 26-32	26,0- 32,0	32	163	228	6	50	270
	FCA4 2 X 8-14	8,0- 14,0	32	36	111	6	50	87
	FCA4 4 X 8-14	8,0- 14,0	32	63	123	6	50	127
	FCA4 6 X 8-14	8,0- 14,0	32	90	150	6	50	163

OTHER COMBINATIONS

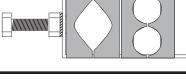
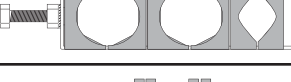
Figure	Name / code	∅D	L	H ₁	H _{max}	 Nm		 gram
	FCA4 3 X 18-24 + 2 X 8-12	3 X 18-24 2 X 8-12	32	168	228	6	50	290
	FCA4 2 X 18-24 + 2 X 8-12	2 X 18-24 2 X 8-12	32	124	184	6	50	223
	FCA4 18-24 + 2 X 8-12	1 X 18-24 2 X 8-12	32	80	155	6	50	156
	FCA4 14-32 + 2 X 8-14	14-32 2 X 8-14	32	90	150	6	50	160
	FCA4 3 X 12-22 + 2 X 6,5/22	3 X 12-22 2 X 6,5/22	22	120	180	6	50	137
	FCA4 3 X 12-22 + 4 X 6,5/22	3 X 12-22 4 X 6,5/22	22	134	194	4	50	191
	FCA4 3 X 12-22 + 6 X 6,5/22	3 X 12-22 6 X 6,5/22	22	147	207	4	50	207
	FCA4 3 X 12-22 + 6 X 5/22	3 X 12-22 6 X 5/22	22	140	207	4	50	198
	FCA4 12-22 + 6 X 5/22	12-22 6 X 5/22	22	74	134	4	50	110
	FCA4 3 X 12-22 + 6,5	3 X 12-22 6,5	22	119	179	4	50	136
	FCA4 12-22 + 2 X 5/22	12-22 2 X 5/22	22	52	112	4	50	82
	FCA4 12-22 + 4 X 5/22	12-22 4 X 5/22	22	63	123	4	50	91
	FCA4 12-22 + 2 X 6,5/22	12-22 2 X 6,5/22	22	55	115	4	50	84
	FCA4 12-22 + 4 X 6,5/22	12-22 4 X 6,5/22	22	68	128	4	50	97
	FCA4 12-22 + 6,5	12-22 6,5	22	53	113	4	50	77
	FCA4 9-16 + 6,5	9-16 6,5	22	46	106	4	50	72
	FCA4 4,2 + 9-16	4,2 9-16	22	46	121	4	50	77
	FCA4 3 X 4,2 + 4,2 + 9-16	4,2 4,2 9-16	22	58	133	4	50	93
	FCA4 14-32 + 2 X 10	14-32 2 X 10	32	80	155	6	50	152